

Centre Number

Candidate Number

Cambridge Young Learners English

# Starters Listening

Version 115

0752



UNIVERSITY *of* CAMBRIDGE  
ESOL Examinations

**English for Speakers of Other Languages**

There are 20 questions.

You will need coloured pens or pencils.

My name is: .....

Blank Page

# Part 1

– 5 questions –

Listen and draw lines. There is one example.

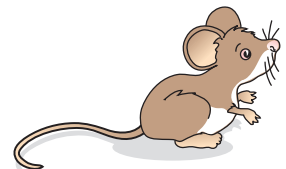
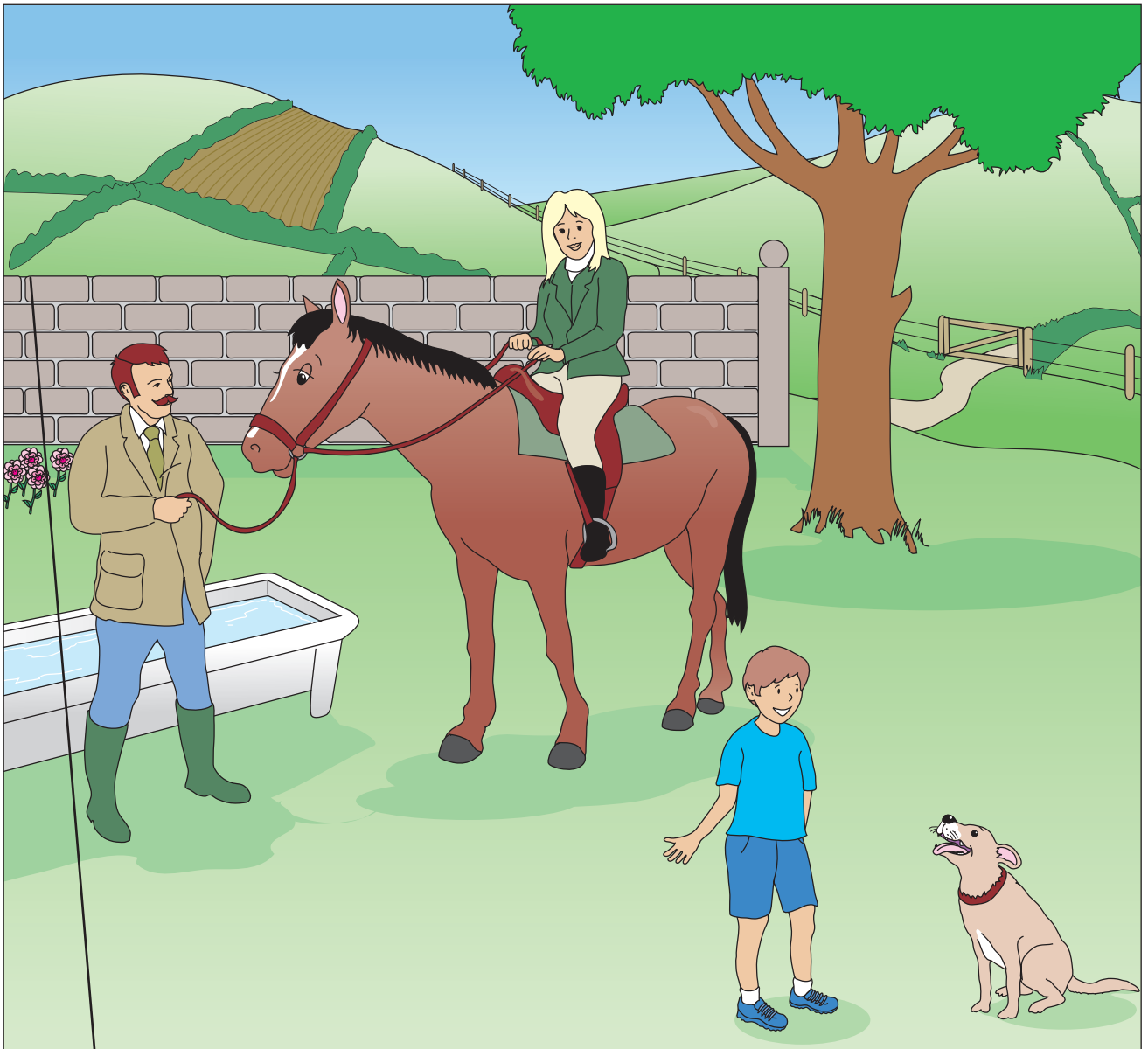
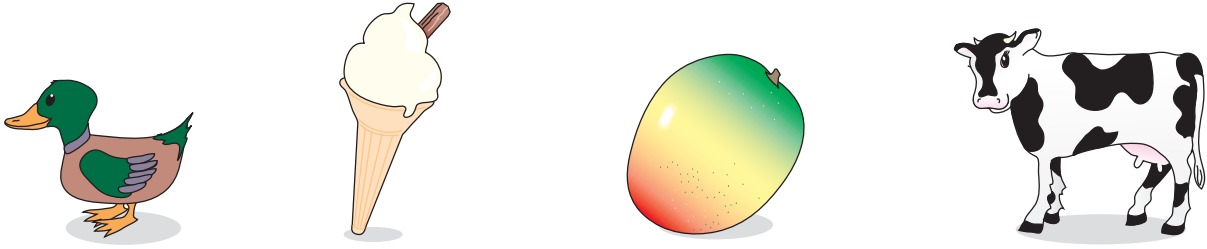

# Part 2

– 5 questions –

Read the question. Listen and write a name or a number.

There are two examples.



## Examples

What's the boy's name?

..... Bill .....

How old is he?

..... 5 .....

## Questions

- 1 Which class is Bill in? Class .....
  
- 2 What's the name of Bill's friend? .....
  
- 3 Where does she live? ..... Street
  
- 4 What number is her house? .....
  
- 5 What's her brother's name? .....

# Part 3

– 5 questions –

Listen and tick (✓) the box. There is one example.

Which is Sam's sister?

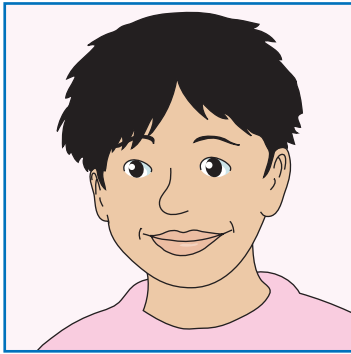

A

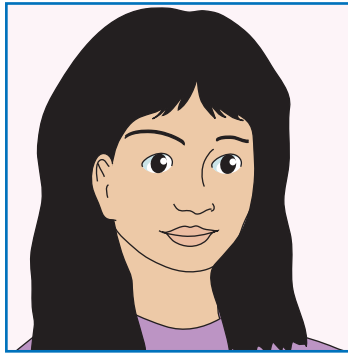

B

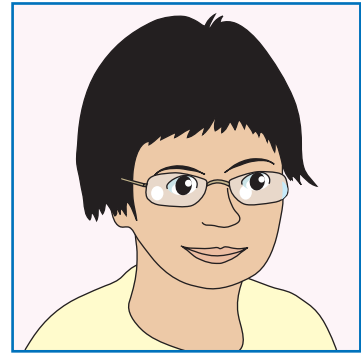

C

1 What's the elephant eating?

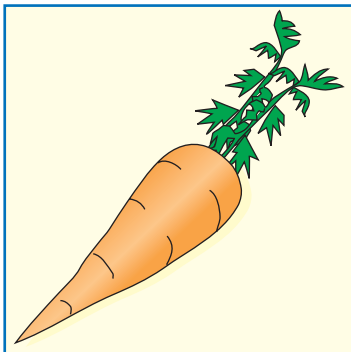

A

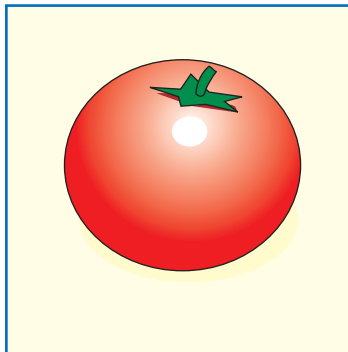

B

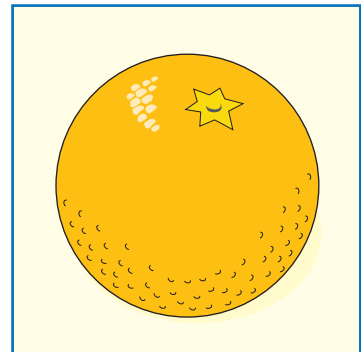

C

2 What's in Kim's box?

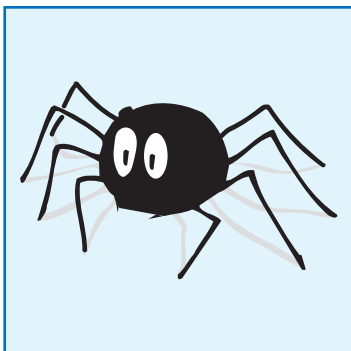

A

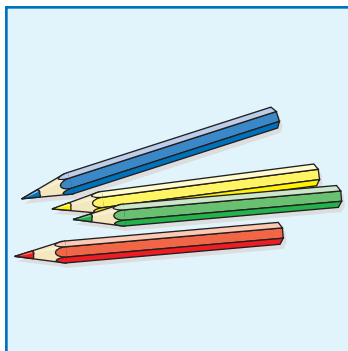

B

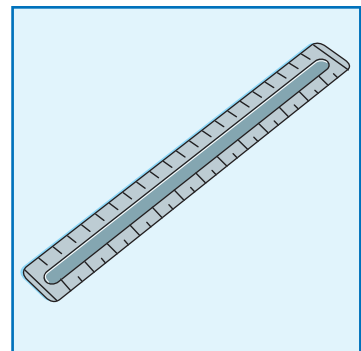

C

3 What's Nick drawing?

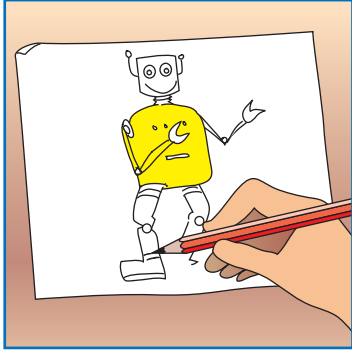

A

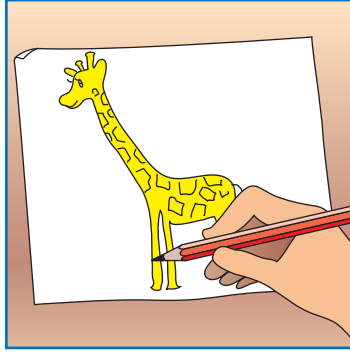

B

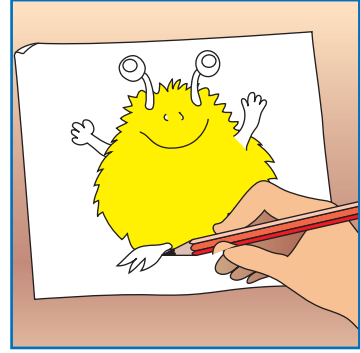

C

4 Where's May's watch?



A

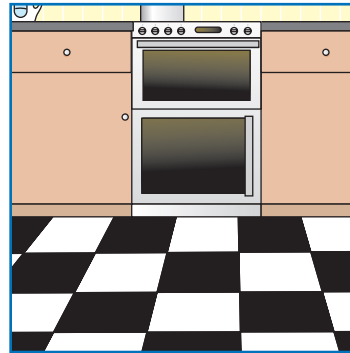

B

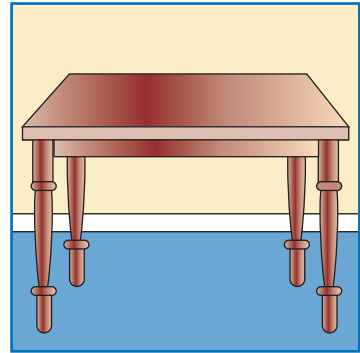

C

5 What's Anna's mum doing?



A



B



C

# Part 4

– 5 questions –

Listen and colour. There is one example.

